



TM4606B

N+P-Channel Enhancement Mode Mosfet

General Description

- Low $R_{DS(ON)}$
- RoHS and Halogen-Free Compliant

Applications

- Load switch
- PWM

Product Summary

N Channel

$V_{DS} = 20V, I_D = 6.0A$
 $R_{DS(ON)} = 28m\Omega (typ.) @ V_{GS} = 4.5V$

P Channel

$V_{DS} = -20V, I_D = -5.0A$
 $R_{DS(ON)} = 66m\Omega (typ.) @ V_{GS} = 4.5V$

100% UIS Tested
 100% R_g Tested



S:SOP-8L

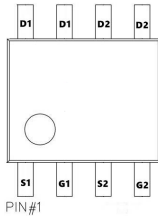

Marking: 4606B

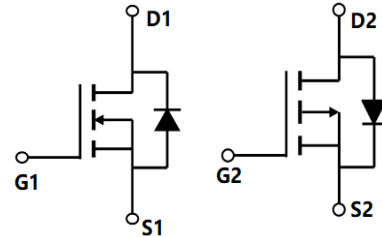
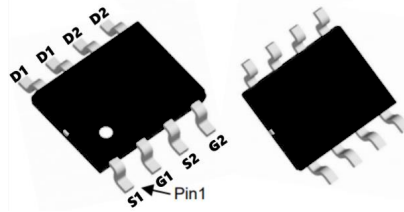

Absolute Maximum Ratings ($T_C = 25^\circ C$ unless otherwise noted)

Symbol	Parameter	Rating		Units
		N-Channel	P-Channel	
V_{DS}	Drain-Source Voltage	20	-20	V
V_{GS}	Gate-Source Voltage	± 12	± 12	V
$I_D @ T_C = 25^\circ C$	Continuous Drain Current, $V_{GS} @ 10V^1$	6	-5	A
$I_D @ T_C = 100^\circ C$	Continuous Drain Current, $V_{GS} @ 10V^1$	3.9	-3.3	A
I_{DM}	Pulsed Drain Current ²	23	-18	A
EAS	Single Pulse Avalanche Energy ³	72	59	mJ
I_{AS}	Avalanche Current	21	-19	A
$P_D @ T_C = 25^\circ C$	Total Power Dissipation ⁴	2.5	2.08	W
T_{STG}	Storage Temperature Range	-55 to 150	-55 to 150	$^\circ C$
T_J	Operating Junction Temperature Range	-55 to 150	-55 to 150	$^\circ C$

Thermal Data

Symbol	Parameter	Typ.	Max.	Unit
$R_{\theta JA}$	Thermal Resistance Junction-Ambient ¹	---	85	$^\circ C/W$
$R_{\theta JC}$	Thermal Resistance Junction-Case ¹	---	50	$^\circ C/W$



TM4606B

N+P-Channel Enhancement Mode Mosfet

N-Channel Electrical Characteristics (T_J=25 °C, unless otherwise noted)

Symbol	Parameter	Test Condition	Min.	Typ.	Max.	Units
Off Characteristic						
V _{(BR)DSS}	Drain-Source Breakdown Voltage	V _{GS} =0V, I _D =250μA	20	-	-	V
I _{DSS}	Zero Gate Voltage Drain Current	V _{DS} =20V, V _{GS} =0V,	-	-	1.0	μA
I _{GSS}	Gate to Body Leakage Current	V _{DS} =0V, V _{GS} =±12V	-	-	±100	nA
On Characteristics						
V _{GS(th)}	Gate Threshold Voltage	V _{DS} =V _{GS} , I _D =250μA	0.4	0.7	1	V
R _{DS(on)}	Static Drain-Source on-Resistance note2	V _{GS} =4.5V, I _D =4A	-	28	30	mΩ
		V _{GS} =2.5V, I _D =3A	-	29	39	
Dynamic Characteristics						
C _{iss}	Input Capacitance	V _{DS} =10V, V _{GS} =0V, f=1.0MHz	-	358	-	pF
C _{oss}	Output Capacitance		-	69.3	-	pF
C _{rss}	Reverse Transfer Capacitance		-	58.5	-	pF
Q _g	Total Gate Charge	V _{DS} =10V, I _D =2A, V _{GS} =4.5V	-	5.6	-	nC
Q _{gs}	Gate-Source Charge		-	0.8	-	nC
Q _{gd}	Gate-Drain("Miller") Charge		-	1	-	nC
Switching Characteristics						
t _{d(on)}	Turn-on Delay Time	V _{DS} =10V, I _D =4A, R _{GEN} =3Ω, V _{GS} =4.5V	-	5	-	ns
t _r	Turn-on Rise Time		-	30	-	ns
t _{d(off)}	Turn-off Delay Time		-	48	-	ns
t _f	Turn-off Fall Time		-	36	-	ns
Drain-Source Diode Characteristics and Maximum Ratings						
I _S	Maximum Continuous Drain to Source Diode Forward Current		-	-	6	A
I _{SM}	Maximum Pulsed Drain to Source Diode Forward Current		-	-	23	A
V _{SD}	Drain to Source Diode Forward Voltage	V _{GS} =0V, I _S =4A	-	-	1.2	V

Notes:1. Repetitive Rating: Pulse Width Limited by Maximum Junction Temperature

2. Pulse Test: Pulse Width≤300μs, Duty Cycle≤0.5%



TM4606B

N+P-Channel Enhancement Mode Mosfet

P-Channel Electrical Characteristics (T_J=25 °C, unless otherwise noted)

Symbol	Parameter	Test Condition	Min.	Typ.	Max.	Units
Off Characteristic						
V _{(BR)DSS}	Drain-Source Breakdown Voltage	V _{GS} =0V, I _D = -250μA	-20	-	-	V
I _{DSS}	Zero Gate Voltage Drain Current	V _{DS} = -20V, V _{GS} =0V,	-	-	-1	μA
I _{GSS}	Gate to Body Leakage Current	V _{DS} =0V, V _{GS} = ±12V	-	-	±100	nA
On Characteristics						
V _{GS(th)}	Gate Threshold Voltage	V _{DS} =V _{GS} , I _D = -250μA	-0.5	-0.7	-1.0	V
R _{DS(on)}	Static Drain-Source on-Resistance <small>note2</small>	V _{GS} = -4.5V, I _D = -3A	-	66	71	mΩ
		V _{GS} = -2.5V, I _D = -2A	-	70	98	
Dynamic Characteristics						
C _{iss}	Input Capacitance	V _{DS} = -10V, V _{GS} =0V, f=1.0MHz	-	503	-	pF
C _{oss}	Output Capacitance		-	67	-	pF
C _{rss}	Reverse Transfer Capacitance		-	58	-	pF
Q _g	Total Gate Charge	V _{DS} = -10V, I _D = -2A, V _{GS} = -4.5V	-	4.1	-	nC
Q _{gs}	Gate-Source Charge		-	0.8	-	nC
Q _{gd}	Gate-Drain("Miller") Charge		-	1.1	-	nC
Switching Characteristics						
t _{d(on)}	Turn-on Delay Time	V _{DD} = -10V, I _D = -3A, R _G =1Ω, V _{GEN} = -4.5V, R _L =1.2Ω	-	11	-	ns
t _r	Turn-on Rise Time		-	52	-	ns
t _{d(off)}	Turn-off Delay Time		-	16	-	ns
t _f	Turn-off Fall Time		-	10	-	ns
Drain-Source Diode Characteristics and Maximum Ratings						
I _S	Maximum Continuous Drain to Source Diode Forward Current		-	-	-5	A
I _{SM}	Maximum Pulsed Drain to Source Diode Forward Current		-	-	-18	A
V _{SD}	Drain to Source Diode Forward Voltage	V _{GS} =0V, I _S = -3A	-	-	-1.2	V

Notes:1. Repetitive Rating: Pulse Width Limited by Maximum Junction Temperature
2. Pulse Test: Pulse Width≤300μs, Duty Cycle≤2%



TM4606B

N+P-Channel Enhancement Mode Mosfet

N-Channel Typical Characteristics

Figure 1: Output Characteristics

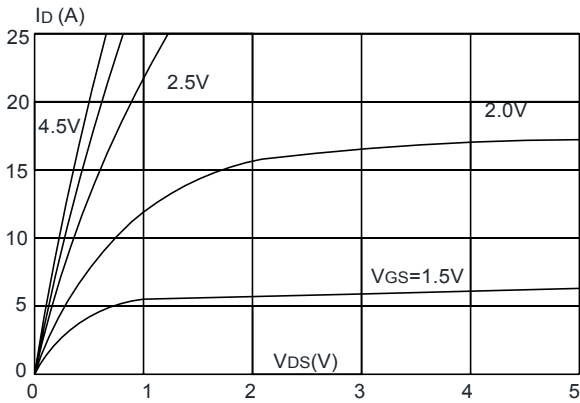

Figure 2: Typical Transfer Characteristics

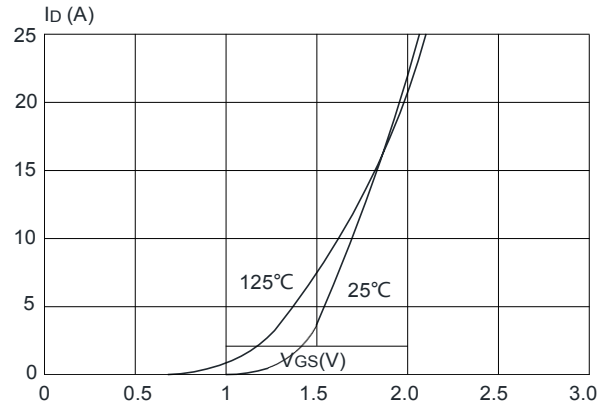

Figure 3: On-resistance vs. Drain Current

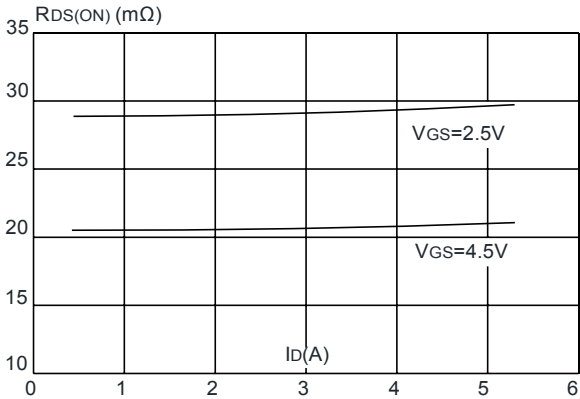

Figure 4: Body Diode Characteristics

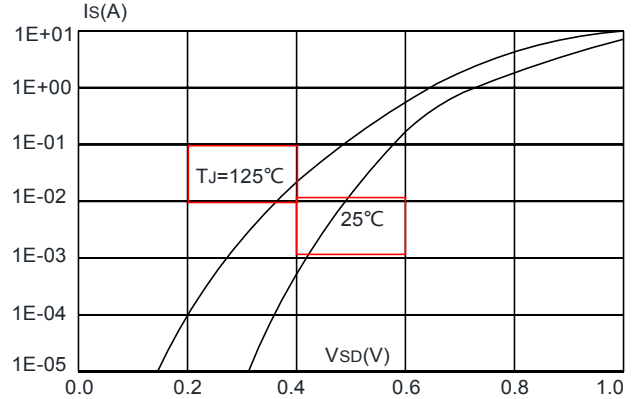

Figure 5: Gate Charge Characteristics

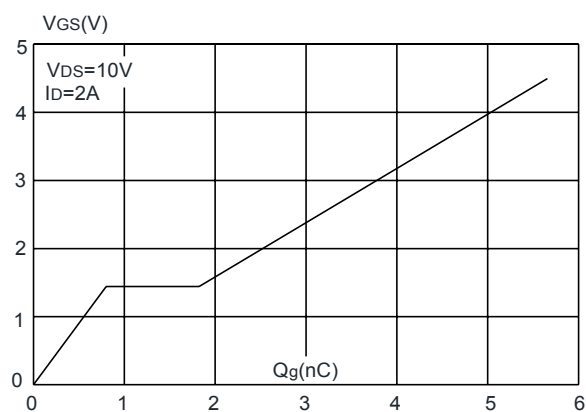
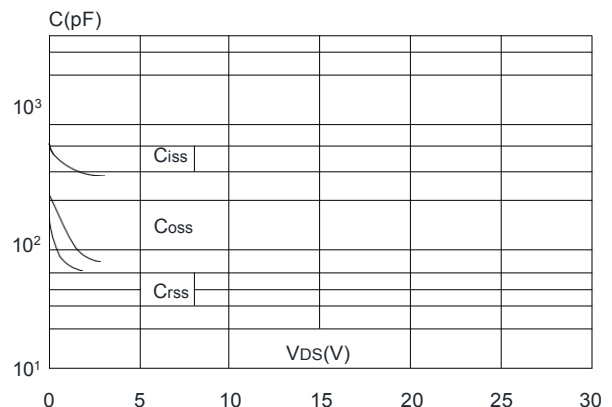

Figure 6: Capacitance Characteristics





TM4606B

N+P-Channel Enhancement Mode Mosfet

P-Channel Typical Characteristics

Figure 1: Output Characteristics

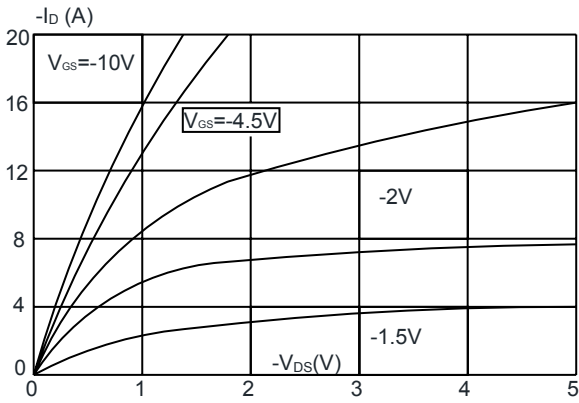

Figure 2: Typical Transfer Characteristics

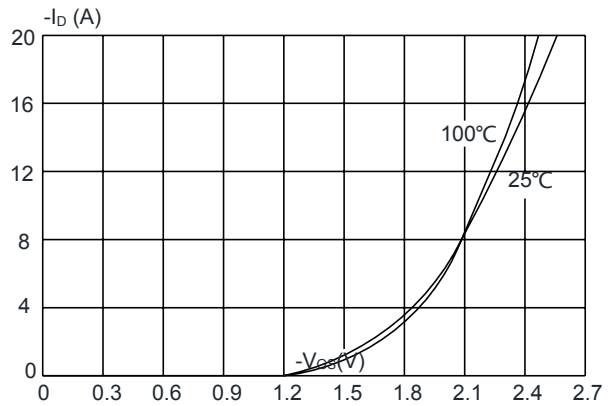

Figure 3: On-resistance vs. Drain Current

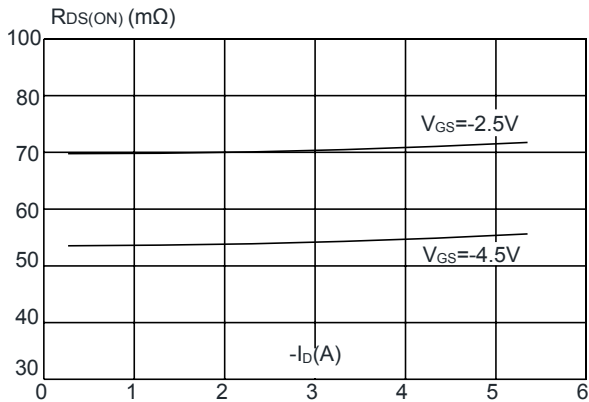

Figure 4: Body Diode Characteristics

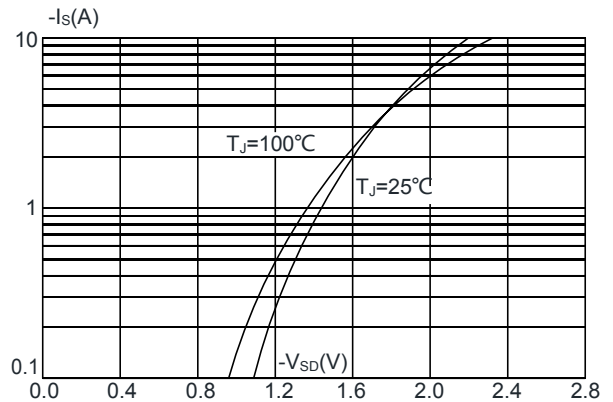

Figure 5: Gate Charge Characteristics

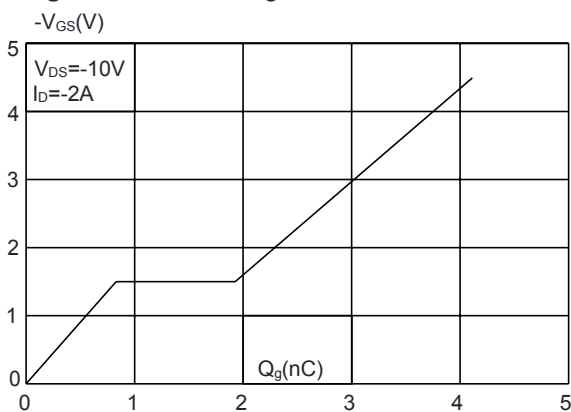
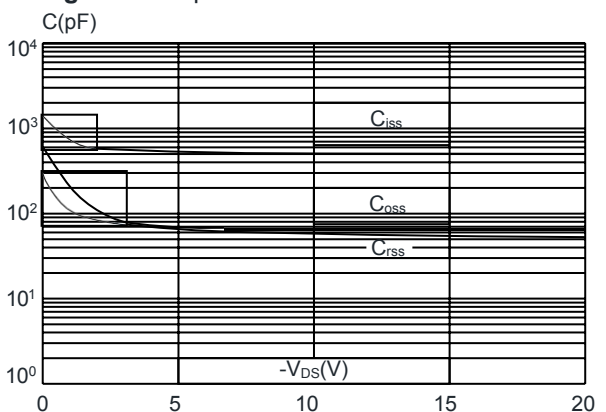
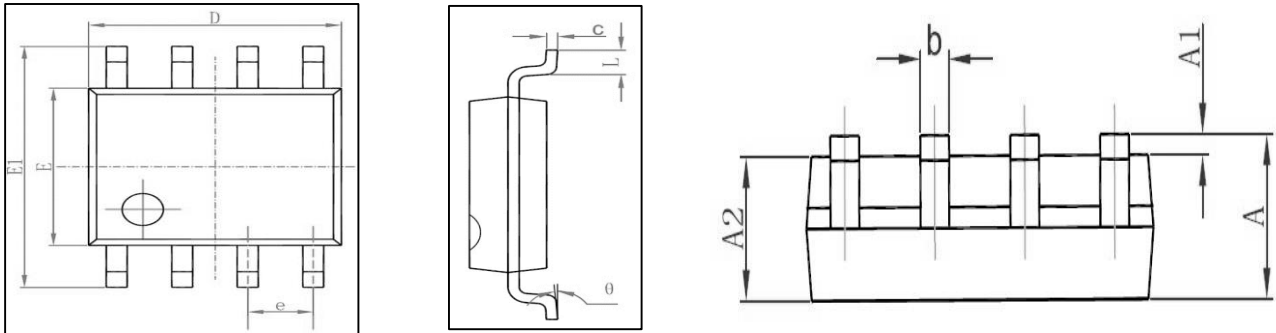

Figure 6: Capacitance Characteristics



Package Mechanical Data:SOP-8L



Symbol	Dimensions In Millimeters		Dimensions In Inches	
	Min	Max	Min	Max
A	1.350	1.750	0.053	0.069
A1	0.100	0.250	0.004	0.010
A2	1.350	1.550	0.053	0.061
b	0.330	0.510	0.013	0.020
c	0.170	0.250	0.006	0.010
D	4.700	5.100	0.185	0.200
E	3.800	4.000	0.150	0.157
E1	5.800	6.200	0.228	0.244
e	1.270 (BSC)		0.050 (BSC)	
L	0.400	1.270	0.016	0.050
θ	0°	8°	0°	8°

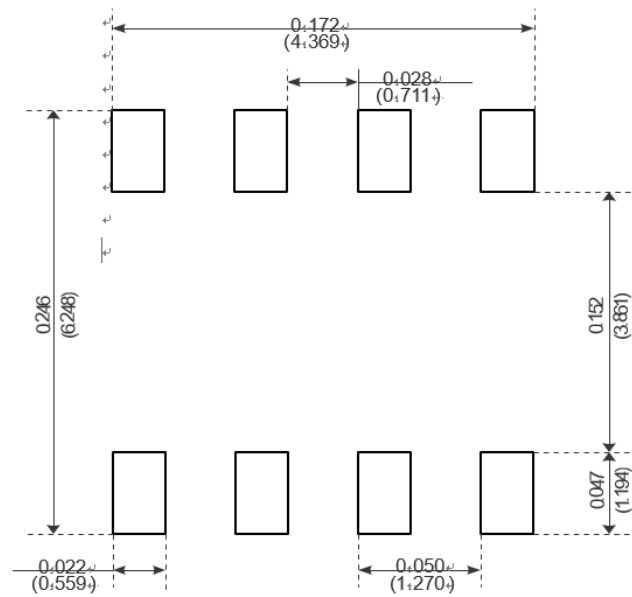

Recommended Minimum Pads